

기본에 혁신을 더하다

S I M P L E
S A F E
S O F T
T E C H N O L O G Y

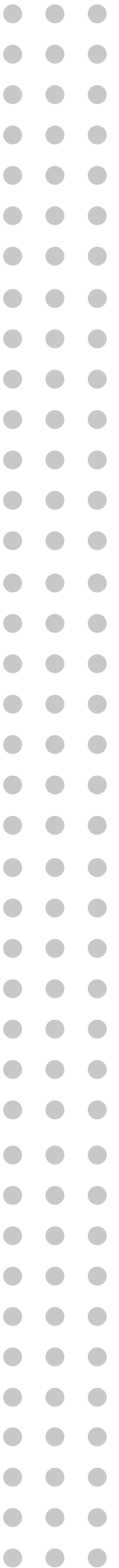

Contents

연혁 | 05

제품소개

핸들 Handle | 08

키퍼 Keeper | 18

스트라이크 Strike | 20

롤러 Roller(PVC용) | 23

롤러 Roller(AL용) | 31

크리센트 Crescent | 33

사출물 Injection(PVC용) | 34

사출물 Injection(AL용) | 36





에이스이노텍(주)
CEO



에이스이노텍(주) 대표이사

한경기



KS 제품인증서



ISO9001



INNO-BIZ확인서



ISO14001



강소기업선정

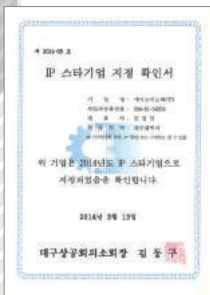

IP스타기업 지정 확인서



스타기업 지정서



기술혁신대전 국무총리상

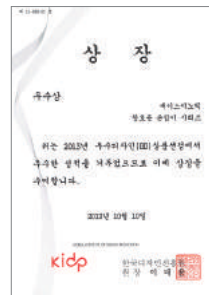

굿디자인 우수상



품질분임조 대통령상 금상

회사연혁

에이스이노텍의 30년!

1987. 04	대구산업 설립(창호용 하드웨어 생산)
1995. 10	한국산업규격 표시 인증(KS)
2002. 05	품질경영시스템 인증(ISO9001)
2004. 01	에이스이노텍 법인 전환(안경규 현 대표이사 취임)
2007. 03	벤처기업 인증. 기술혁신형중소기업(INNO-BIZ 확인)
2011. 06	환경경영시스템 인증(ISO14001)
2011. 07	성서5차단지 분사/공장 이전
2013. 10	일하기 좋은 으뜸기업 선정
2014. 03	IP-STAR 기업 선정
2014. 07	대구스타기업 선정
2015. 09	대구 수출기업(WEBSEAL) 인증
2015. 12	출산친화기업 지정
2015. 12	인재육성형기업 지정
2016. 12	수출 유망 중소기업 선정
2017. 04	강소기업 선정
2018. 12	가족친화인증
2020. 01	청년친화 강소기업 선정

수상이력

품질, 기술, 디자인 공인 인증!

2009 ~ 2014	전국 품질분임조 경진대회 대통령상 수상
2012	중소기업 기술혁신대전 국무총리상 수상
2013	한국 디자인 진흥원(KIDP) Good Design 창호용 핸들 부문 우수상
2017	고용노동부 장관 표창장 수상
2017	산업통상자원부 국가표준화 대상 수상
2020	중소벤처기업부 장관 표창
2022	과학기술정보통신부 장관상 수상



SLIDING WINDOW HARDWARE

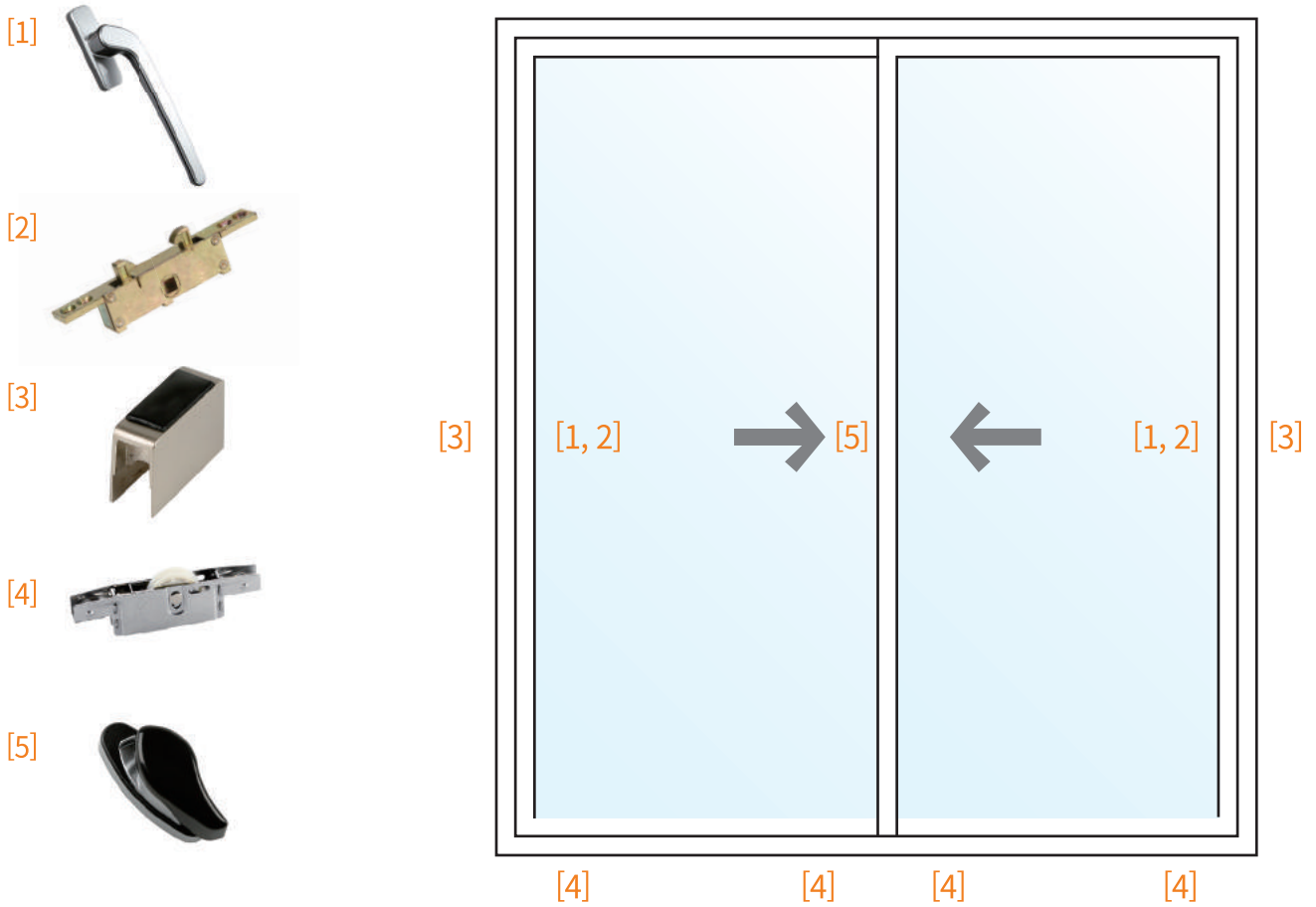

No.	Item Name	Quantity	Page
1	핸들 Handle	2	8
2	키퍼 Keeper	2	18
3	스트라이크 Strike	2	20
4	롤러 Roller	4	23
5	크리센트 Crescent	1	33
6	사출물 Injection		36

○ H09LA SecuSan®



○ H09L

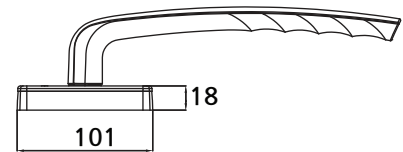
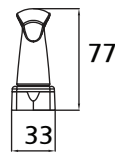
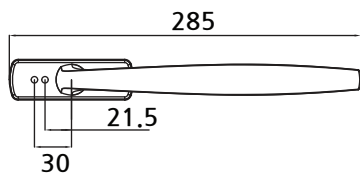

**창호 핸들 세계 1위 기업 독일 'HOPPE'와 MOU 체결
대한민국 건축 양식에 적합한 슬라이딩 오토락 핸들**

아노다이징 핸들

알루미늄 표면에 얇은 산화막을 만들어 금속 내부를 보호하는 방법

- 뛰어난 내식성(부식에 대한 저항성)으로 녹 및 변색방지
- 일반 알루미늄 대비 3배 강성(변형 저항정도)의 입증된 내구성

○ H09MA **SecuSan[®]**



○ H09M

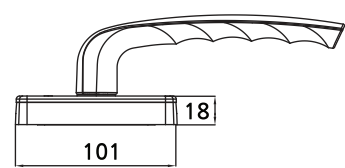
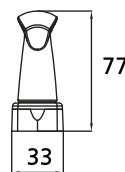
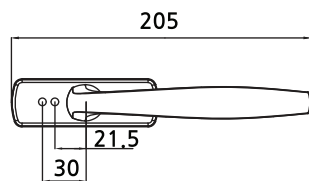

HOPPE의 'SecuSan' 활용한 오토락 항균 핸들

항균 핸들 **SecuSan[®]**

SecuSan : 핸들에 특수 표면 처리로 항균성 표면을 구현한 제품

- 은이온(Silver Ion) 활용 통한 세균의 세포막 파괴, 세균 위협 보호
- 독일 외부 전문기관 테스트 통한 세균 증식 99%이상 차단 입증

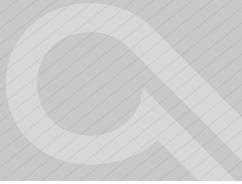

○ **H09SA** SecuSan®

○ **H09S**

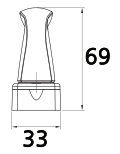
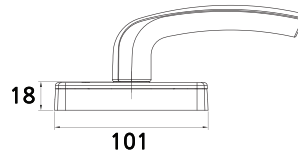
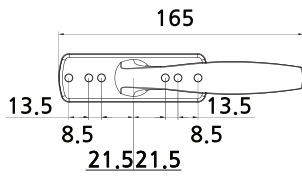

Handle-Natural Line

H10L
한샘 ODM

H10M
한샘 ODM

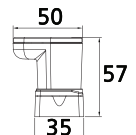
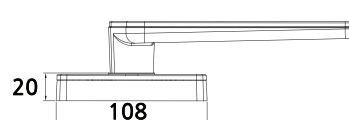
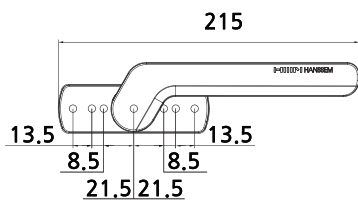
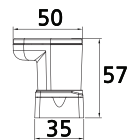
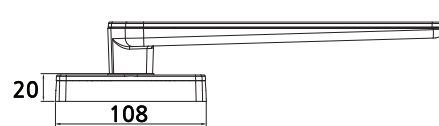
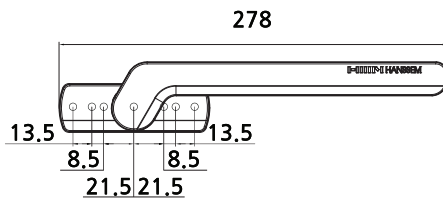

○ H08L

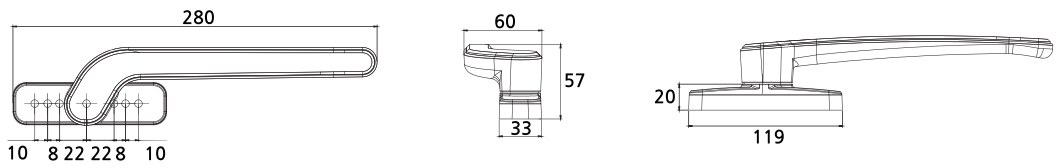

○ H08M

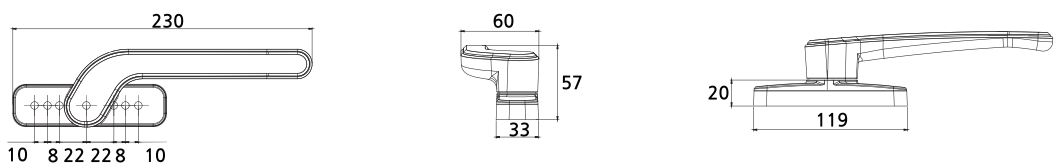



H08G

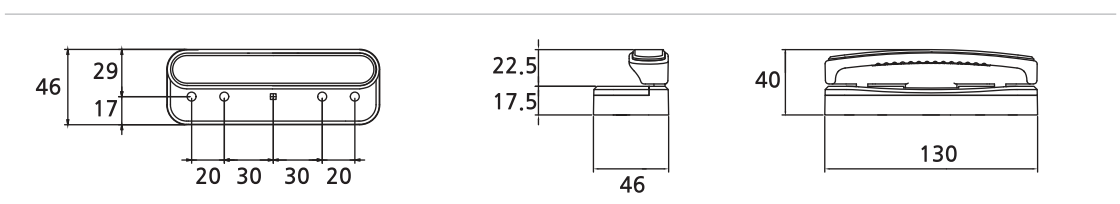

H10G

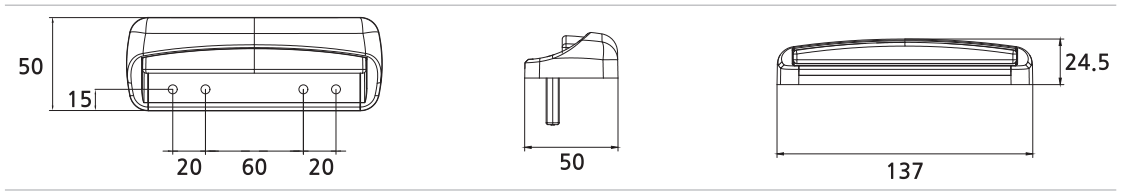

○ H05L

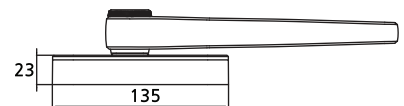
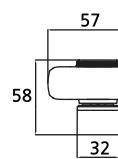
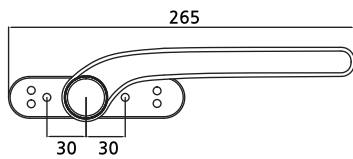



H03L

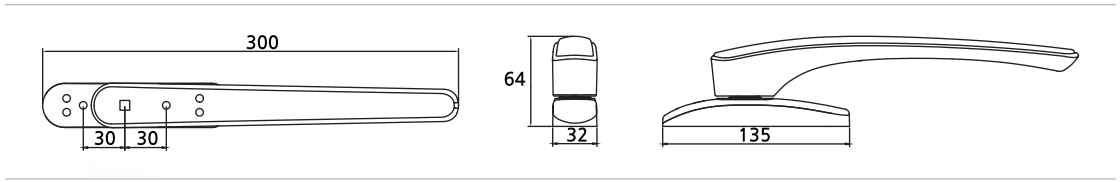

H03M

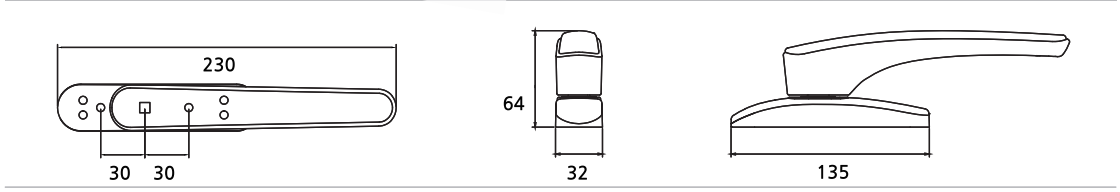

Handle-기타 핸들

H02F

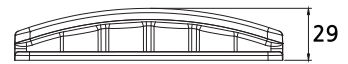
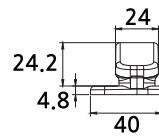
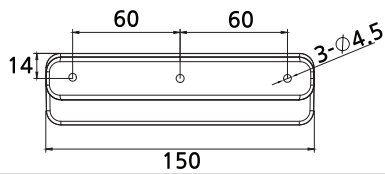

H03F

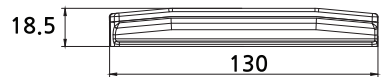
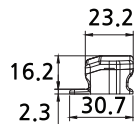
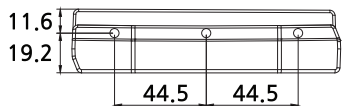
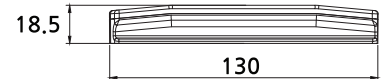
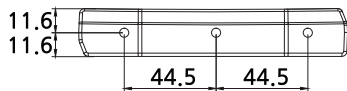
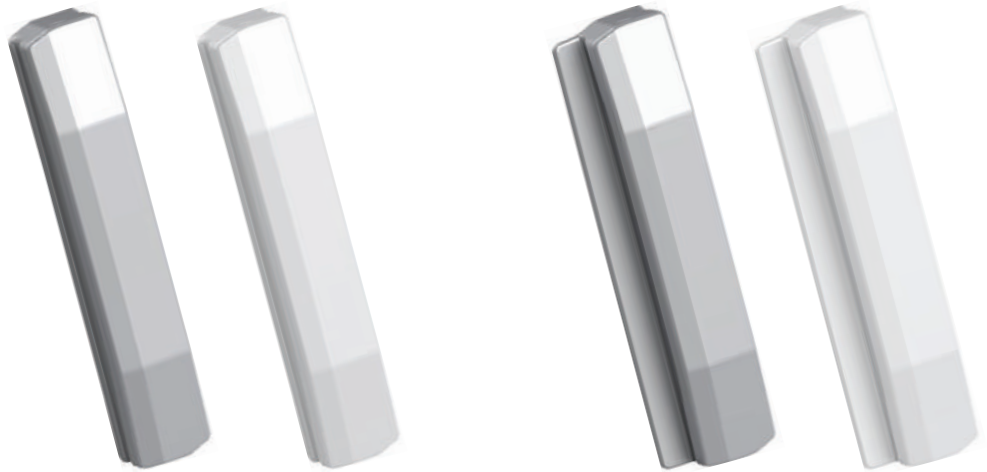



H09G 방충망 핸들

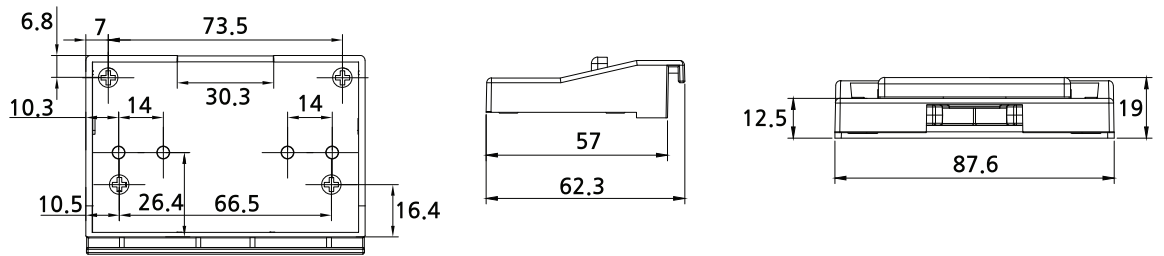

H01F

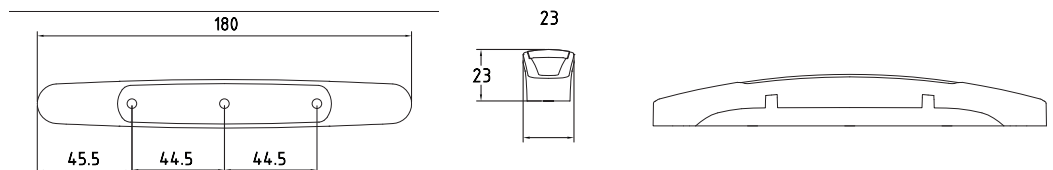

K01

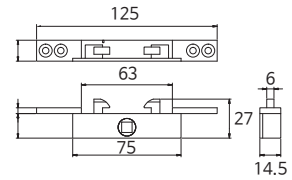

제품명	K01
제품 사양	125X14.5X27 (가로X세로X높이) 캐스팅 : Zn
용도	115G 키퍼

K02

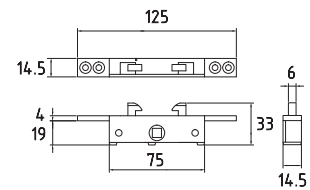
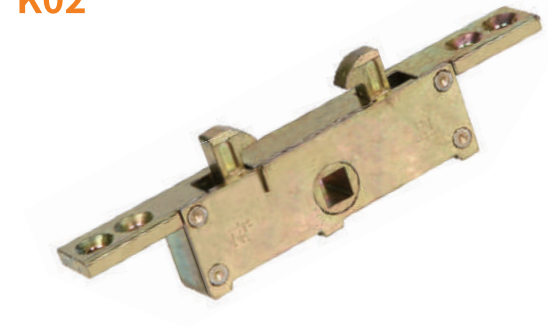

제품명	K02
제품 사양	125X14.5X33 (가로X세로X높이) 캐스팅 : Zn
용도	115B 키퍼

K05

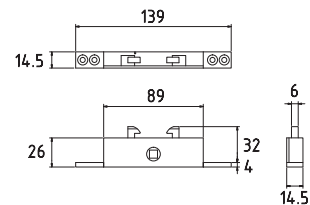
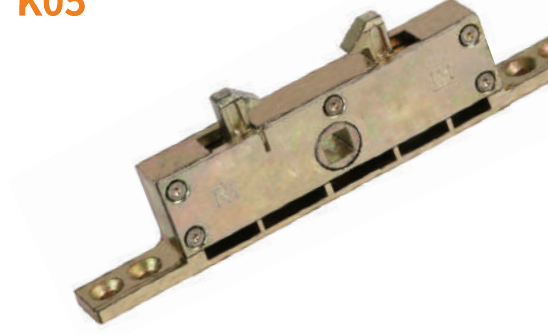

제품명	K05
제품 사양	139X14.5X36 (가로X세로X높이) 캐스팅 : Zn
용도	124B 키퍼

K06

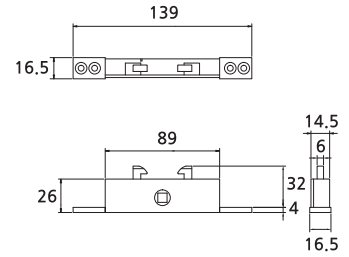
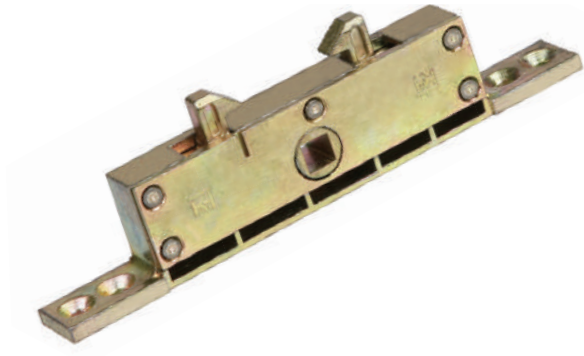

제품명	K06
제품 사양	139X16.5X36 (가로X세로X높이) 캐스팅 : Zn
용도	130B 키퍼

K21

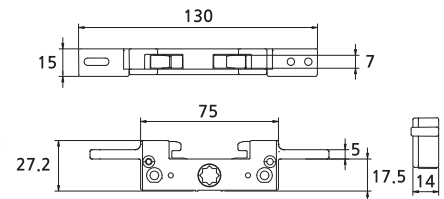
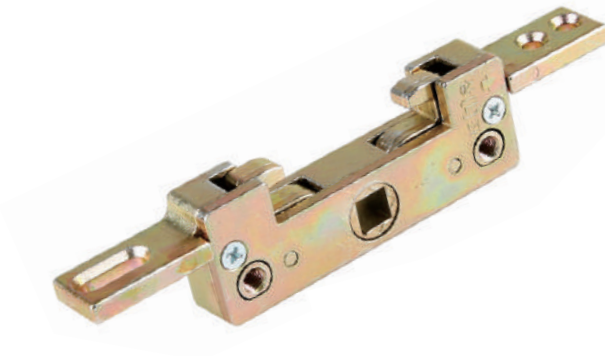

제품명	K21
제품 사양	130X15X27.2 (가로X세로X높이) 캐스팅 : Zn
용도	115G 3축 키퍼

K18

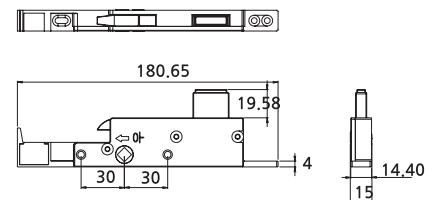

제품명	K18
제품 사양	180X14X53 (가로X세로X높이) 캐스팅 : Zn
용도	발코니 무타공용 ※이지오픈 기능 창문떨림방지 기능

S01

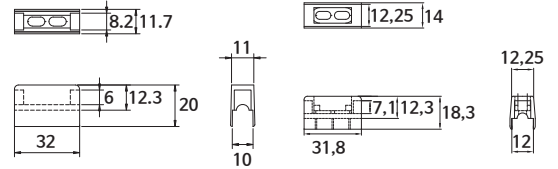

제품명	S01
제품 사양	10mm : 32X10X20 12mm : 31.8X12X14 (가로X세로X높이) 캐스팅 : Zn
용도	115G 스트라이크(10mm용) 115G 스트라이크(12mm용)

S14

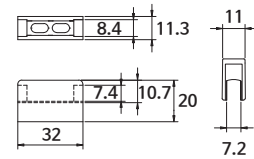

제품명	S14
제품 사양	10mm : 32X7.2X20 (가로X세로X높이) 캐스팅 : Zn
용도	110B 스트라이크

S02

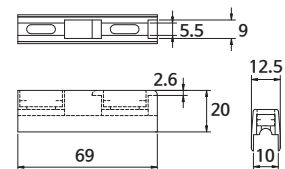

제품명	S02
제품 사양	10mm : 69X10X20 (가로X세로X높이) 캐스팅 : Zn
용도	10mm 스트라이크

S06

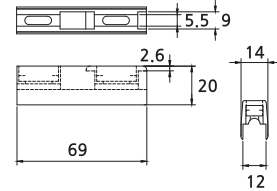

제품명	S06
제품 사양	12mm : 69X12X20 (가로X세로X높이) 캐스팅 : Zn
용도	12mm 스트라이크

S21

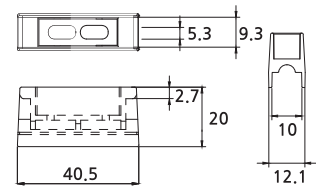

제품명	S21
제품 사양	10mm : 40.5X10X20 (가로X세로X높이) 캐스팅 : Zn
용도	115G 3축 스트라이크

S18

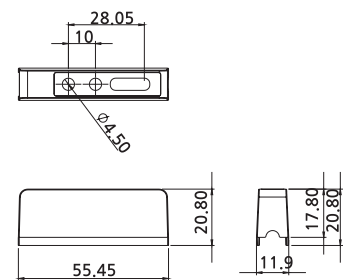

제품명	S18
제품 사양	10mm : 55.4X10X20.8 (가로X세로X높이) 캐스팅 : Zn
용도	발코니 무타공용 ※이지오픈 기능 창문떨림방지 기능

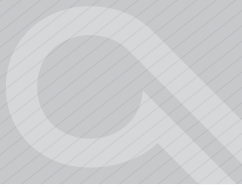

금형설계



프레스



캐스팅



사출

자동화

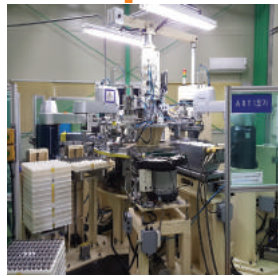

자동 조립

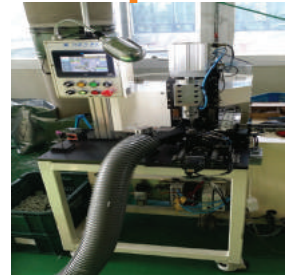

휠 후가공

품질관리



복합 테스터

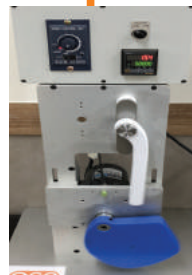

개폐 테스터

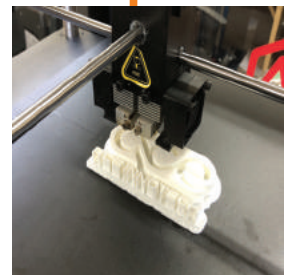

3D 프린터

RP01S

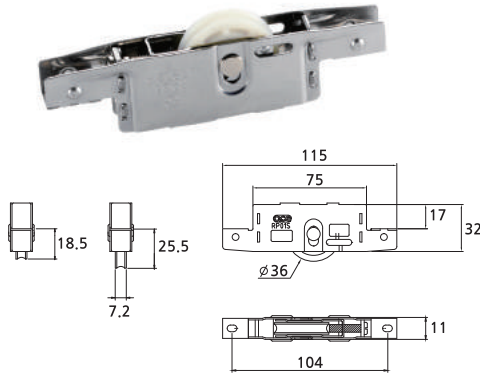

제품명	RP01S
제품 재질	Housing-STS 430 Wheel-Nylon, Acetal Bearing-Ball
제품 사양	최대하중 : 60kg 포장단위 : 200EA 비고 : 조절
용도	115G싱글(내창용)

RP01T

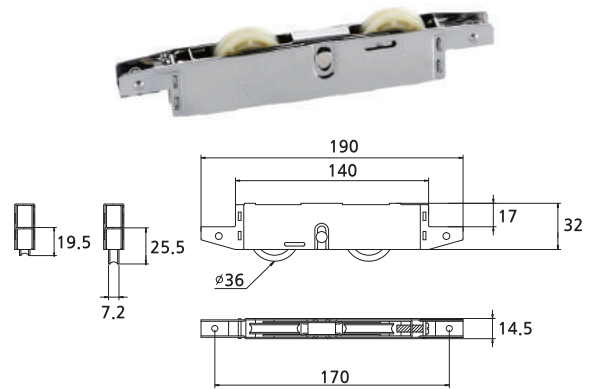

제품명	RP01T
제품 재질	Housing-STS 430 Wheel-Nylon Bearing-Ball
제품 사양	최대하중 : 120kg 포장단위 : 120EA 비고 : 조절
용도	115G트윈(내창용)

RP03S

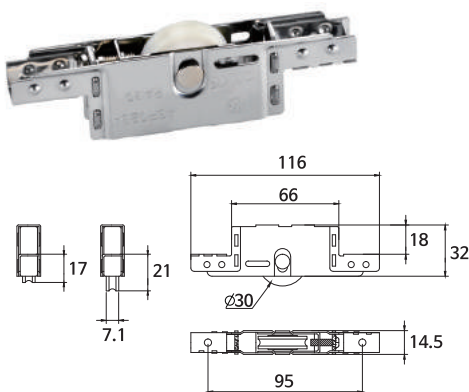

제품명	RP03S
제품 재질	Housing-STS 430 Wheel-Acetal Bearing-Ball
제품 사양	최대하중 : 60kg 포장단위 : 250EA 비고 : 조절
용도	115LSB(내창용)

RP03T

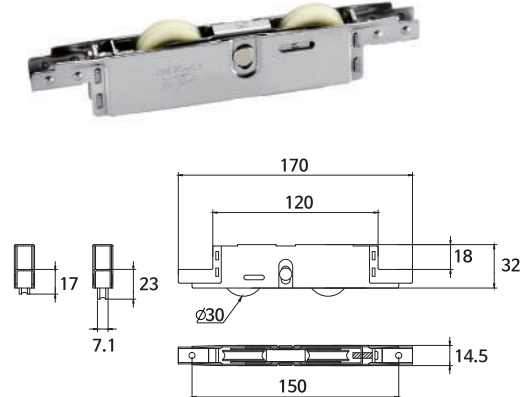

제품명	RP03T
제품 재질	Housing-STS 430 Wheel-Nylon Bearing-Ball
제품 사양	최대하중 : 120kg 포장단위 : 120EA 비고 : 조절
용도	115LTB(내창용)

RP02S

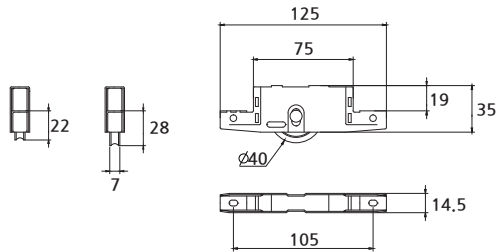

제품명	RP02S
제품 재질	Housing-ST5 430 Wheel-Nylon Bearing-Ball
제품 사양	최대하중 : 80kg 포장단위 : 200EA 비고 : 조절
용도	115B 싱글(발코니용) / 115BNS

RP02T

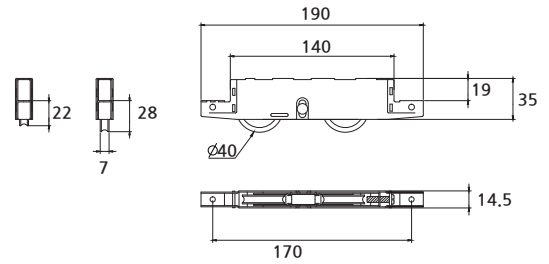

제품명	RP02T
제품 재질	Housing-ST5 430 Wheel-Nylon Bearing-Ball
제품 사양	최대하중 : 120kg 포장단위 : 100EA 비고 : 조절
용도	115B 트윈(발코니용) / 115BNT

RP52S

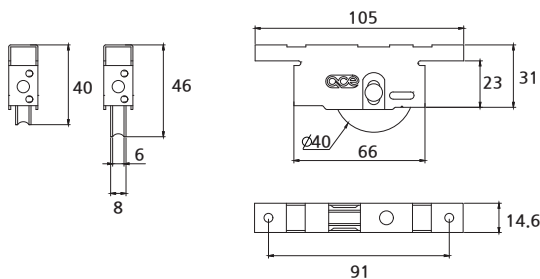

제품명	RP52S
제품 재질	Housing-ST5 430 Wheel-Nylon Bearing-Ball
제품 사양	최대하중 : 80kg 포장단위 : 200EA 비고 : 조절
용도	124B 싱글(발코니용)

RP05T

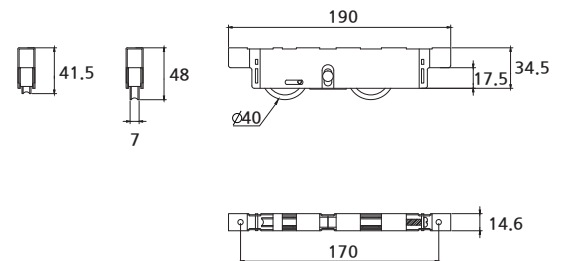

제품명	RP05T
제품 재질	Housing-ST5 430 Wheel-Nylon Bearing-Ball
제품 사양	최대하중 : 120kg 포장단위 : 100EA 비고 : 조절
용도	124B 트윈(발코니용)



RP53S

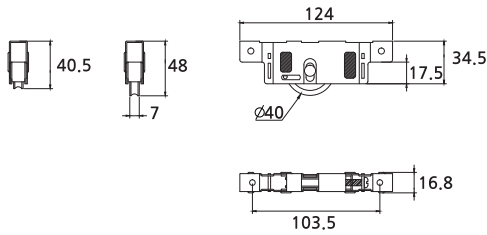

RP06T

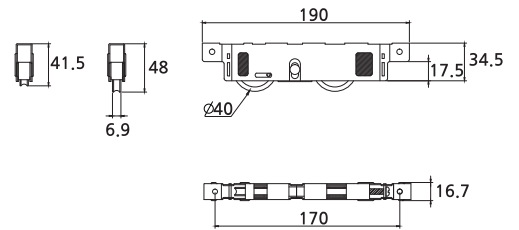

제품명	RP53S
제품 재질	Housing-STS 430 Wheel-Nylon Bearing-Ball
제품 사양	최대하중 : 80kg 포장단위 : 200EA 비고 : 조절
용도	130B 싱글(발코니용)

제품명	RP06T
제품 재질	Housing-STS 430 Wheel-Nylon Bearing-Ball
제품 사양	최대하중 : 120kg 포장단위 : 100EA 비고 : 조절
용도	130B 트윈(발코니용)

RP15T 주문제작

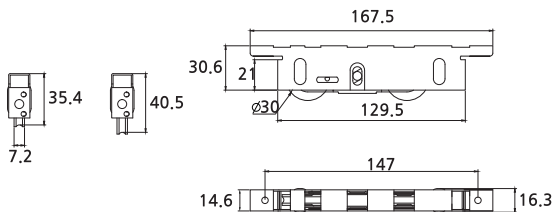

제품명	RP15T
제품 재질	Housing-STS430 Wheel-Nylon Bearing-Ball
제품 사양	최대하중 : 100Kg 포장단위 : 120EA 비고 : 조절
용도	130BH 트윈(발코니)



○ RP01S(Y)

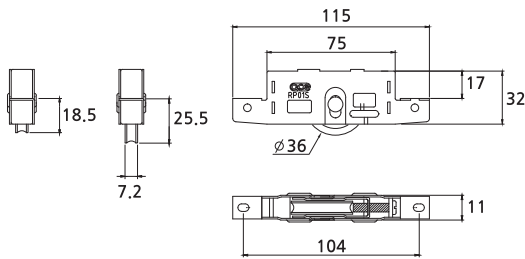

제품명	RP01S(Y)
제품 재질	Housing-Posmag Wheel - Nylon
제품 사양	적정하중 : 60kg 포장단위 : 200EA 비고 : 조절
용도	125 LG용 127W 영림용 127B 영림용 131B 영림용

○ RP01T(Y)

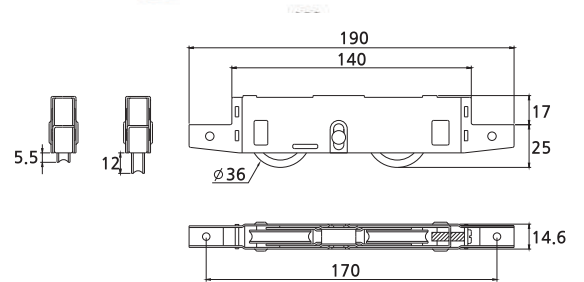

제품명	RP01T(Y)
제품 재질	Housing-Posmag Wheel - Nylon
제품 사양	적정하중 : 120kg 포장단위 : 120EA 비고 : 조절
용도	125 LG용 127W 영림용 127B 영림용 131B 영림용

RP21S

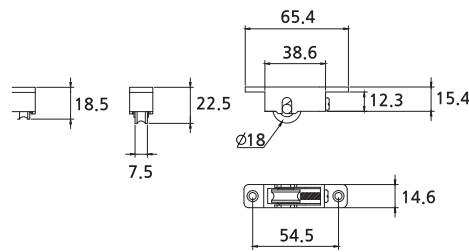

제품명	RP21S
제품 재질	Housing-Zn Wheel-Acetal Bearing-Oilless
제품 사양	최대하중 : 40kg 포장단위 : 600EA 비고 : 조절
용도	115G 무개공(BBR)

RP22S

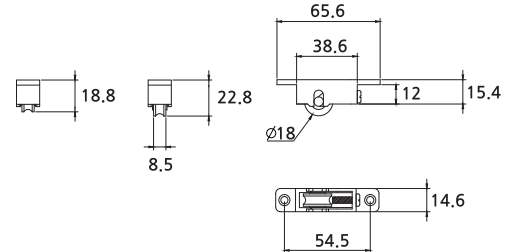

제품명	RP22S
제품 재질	Housing-Zn Wheel-Steel Bearing-Ball
제품 사양	최대하중 : 60kg 포장단위 : 500EA 비고 : 조절
용도	115G 무개공(PBR)

RP10S

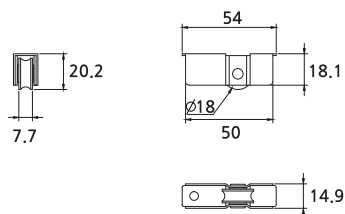

제품명	RP10S
제품 재질	Housing-ST5 430 Wheel-Acetal Bearing-Oilless
제품 사양	최대하중 : 20kg 포장단위 : 1,000EA 비고 : 고정
용도	115G 보조

RP04S

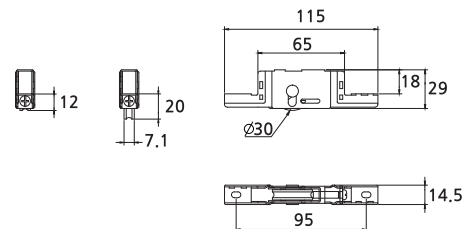

제품명	RP04S
제품 재질	Housing-ST5 430 Wheel-Acetal Bearing-Ball
제품 사양	최대하중 : 60kg 포장단위 : 240EA 비고 : 조절
용도	115M 조절

○ RP12S

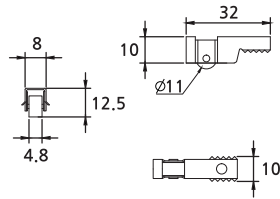

제품명	RP12S
제품 재질	Housing-STS430 Wheel-Acetal Bearing-Oilless
제품 사양	적정하중 : 10kg 포장단위 : 5,000EA 비고 : 고정(Fixed)
용도	MF115G 방충망(12.5)

○ RP13S

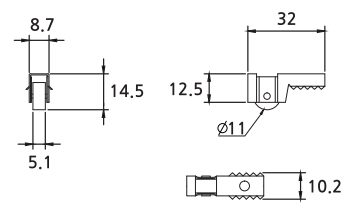

제품명	RP13S
제품 재질	Housing-STS430 Wheel-Acetal Bearing-Oilless
제품 사양	적정하중 : 10kg 포장단위 : 5,000EA 비고 : 고정(Fixed)
용도	MF115B 방충망(14.5)

○ RP14S

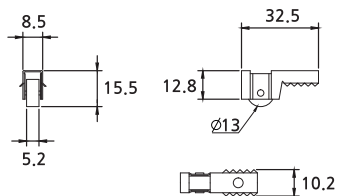

제품명	RP14S
제품 재질	Housing-STS430 Wheel-Acetal Bearing-Oilless
제품 사양	적정하중 : 10kg 포장단위 : 5,000EA 비고 : 고정(Fixed)
용도	MF115B 방충망(15.5)

○ RP15S

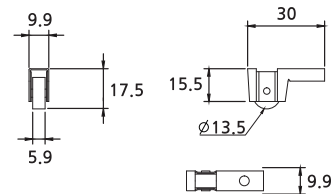

제품명	RP15S
제품 재질	Housing-STS430 Wheel-Acetal Bearing-Oilless
제품 사양	적정하중 : 10kg 포장단위 : 5,000EA 비고 : 고정(Fixed)
용도	MF115B 방충망(17.5)

RP30S

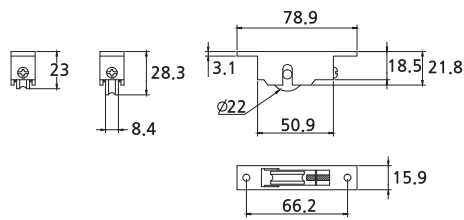

제품명	RP30S
제품 재질	Housing-Zn Wheel-Acetal Bearing-Ball
제품 사양	최대하중 : 40kg 포장단위 : 400EA 비고 : 조절
용도	복합창 / 학교창

RP29T

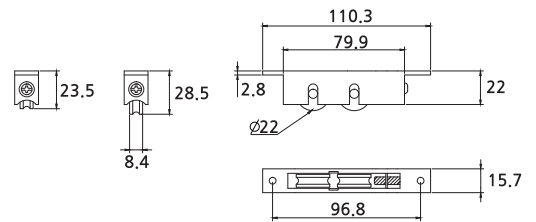

제품명	RP29T
제품 재질	Housing-Zn Wheel-Acetal Bearing-Ball
제품 사양	최대하중 : 60kg 포장단위 : 240EA 비고 : 조절
용도	복합창 / 학교창

RP47S

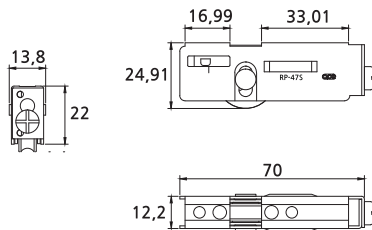

제품명	RP47S
제품 재질	Housing-ST5430 Wheel-Acetal Bearing-Ball
제품 사양	최대하중 : 40Kg 포장단위 : 400EA 비고 : 조절
용도	학교창

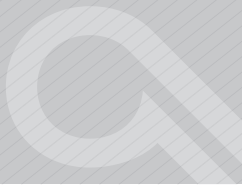

○ RP33S

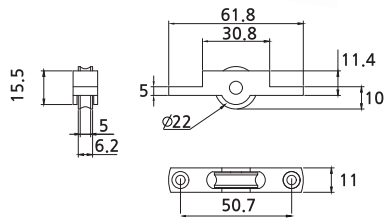

○ RP34S

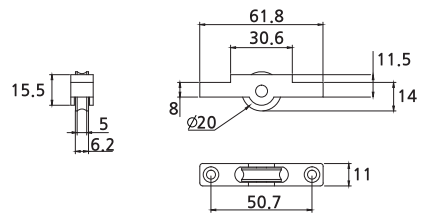

제품명	RP33S
제품 재질	Housing-Nylon Wheel-Acetal Bearing-Oilless
제품 사양	최대하중 : 20kg 포장단위 : 2,000EA 비고 : 고정
용도	RA20A

제품명	RP34S
제품 재질	Housing-Nylon Wheel-Acetal Bearing-Oilless
제품 사양	최대하중 : 20kg 포장단위 : 2,000EA 비고 : 고정
용도	RA20B

RA01S 주문제작

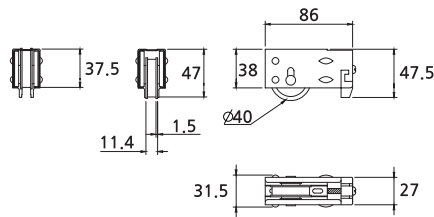

제품명	RA01S
제품 재질	Housing-ST3, STL Wheel-Acetal Bearing-Ball
제품 사양	최대하중 : 80kg 포장단위 : 160EA 비고 : 조절
용도	동양 110mm 스텐(PBR)

RA01T 주문제작

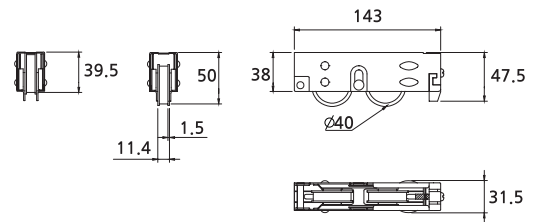

제품명	RA01T
제품 재질	Housing-ST3 Wheel-Acetal Bearing-Ball
제품 사양	최대하중 : 130kg 포장단위 : 80EA 비고 : 조절
용도	동양 110mm 스텐트윈(PBR)

RA05S 주문제작

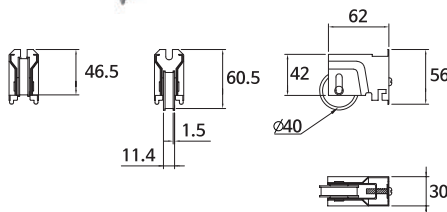

제품명	RA05S
제품 재질	Housing-ST3, STL Wheel-Acetal Bearing-Ball
제품 사양	최대하중 : 80kg 포장단위 : 250EA 비고 : 조절
용도	남선 112mm 스텐(PBR)

RA08S 주문제작

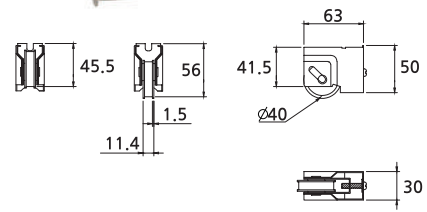

제품명	RA08S
제품 재질	Housing-ST3, STL Wheel-Acetal Bearing-Ball
제품 사양	최대하중 : 80kg 포장단위 : 250EA 비고 : 조절
용도	남선 105mm 스텐(PBR)

RA10S

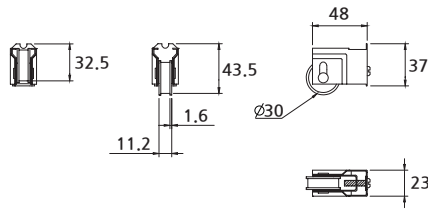

제품명	RA10S
제품 재질	Housing-STS, STL Wheel-Acetal Bearing-Ball
제품 사양	최대하중 : 60kg 포장단위 : 300EA 비고 : 조절
용도	남선 85mm스텐(PBR) 남선 85mm니켈(BBR)

RA12S

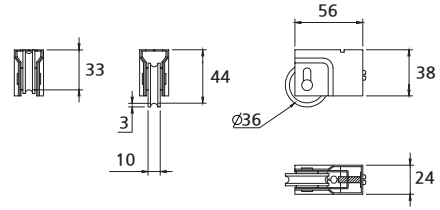

제품명	RA12S
제품 재질	Housing-STL Wheel-Acetal Bearing-Bush
제품 사양	최대하중 : 40kg 포장단위 : 300EA 비고 : 조절
용도	동양 80mm 니켈(BBR)

RA13S

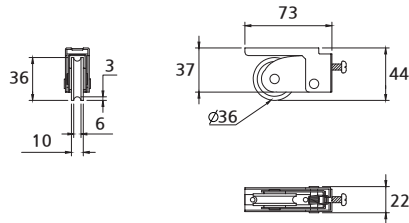

제품명	RA13S
제품 재질	Housing-STL Wheel-Acetal Bearing-Bush
제품 사양	최대하중 : 40kg 포장단위 : 300EA 비고 : 조절
용도	현대 80mm 니켈(BBR)

○ C08S

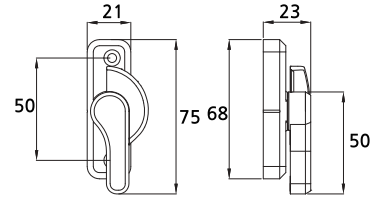

제품명	C08S (2W, 4W)
제품 사양	최대하중 : 40kg 포장단위 : 300EA

○ C08M

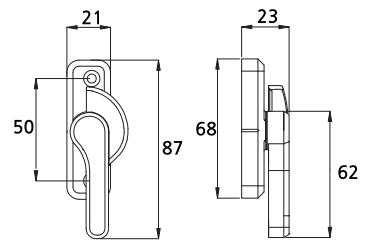

제품명	C08M (2W, 4W)
제품 사양	캐스팅(마운트 + 핸들) : ZN 포장단위 : 300EA



IWP51D IWP52D IWP53D IWP54D IWP56D IWP57D

코드	품명	가로	세로	높이	포장단위
IWP51D	MF115 풍지판	27.5	24	20	2,500EA
IWP52D	96 풍지판	33.5	46	10	1,500EA
IWP53D	115 풍지판	41.5	45	15	1,500EA
IWP54D	115B 풍지판	41.5	45.5	24	1,200EA
IWP56D	140B 풍지판	46.2	60	32	600EA
IWP57D	140H 풍지판	46.2	60	37	480EA

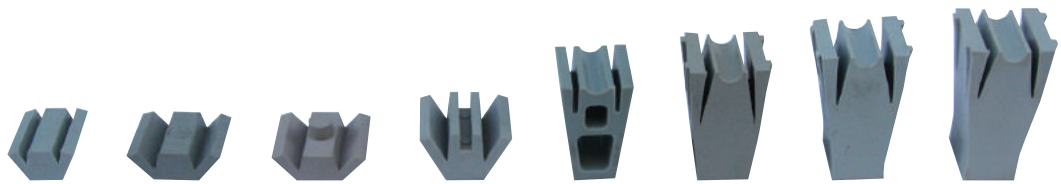

IST38D IST39D IST40D IST41D IST42D IST43D IST44D IST45D

코드	품명	가로	세로	높이	포장단위
IST38D	96 SF스토퍼	9	20	9.5	8,000EA
IST39D	115 SF스토퍼	12	20	8.5	6,000EA
IST40D	115G SF스토퍼	12	20	12.5	6,000EA
IST41D	115B SF스토퍼	10	20	16	4,000EA
IST42D	115WF SF스토퍼	12	20	30	2,000EA
IST43D	34 SF스토퍼	14	20	34	1,500EA
IST44D	37 SF스토퍼	14	20	37	1,500EA
IST45D	40 SF스토퍼	14	20	40	1,500EA

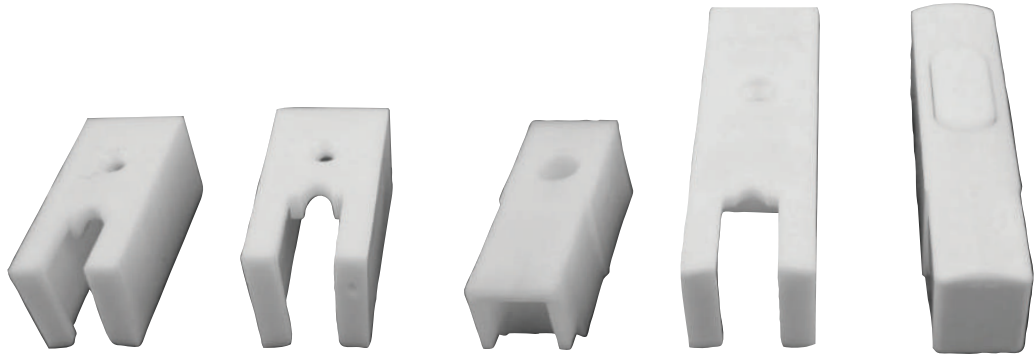

IST46D

IST47D

IST48D

IST49D

IST50D

코드	품명	가로	세로	높이	포장단위
IST46D	96 BF스토퍼	20	44	19.5	1,200EA
IST47D	115 BF스토퍼	22	44	22	1,200EA
IST48D	115B BF스토퍼	17.5	50	19	1,200EA
IST49D	115L BF스토퍼	24	85	25	500EA
IST50D	140B BF스토퍼	18	89	24.5	500EA

IST52D

IST53D

IST54D

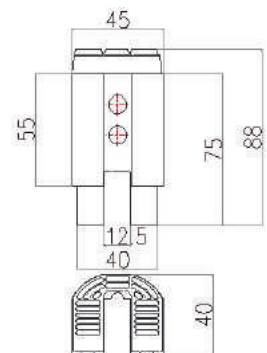
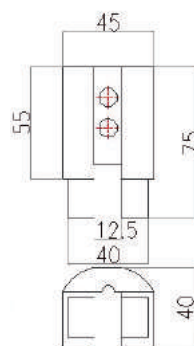
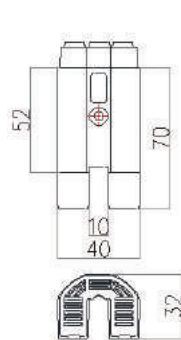

포장단위	350EA	300EA	250EA
------	-------	-------	-------

IWP01D

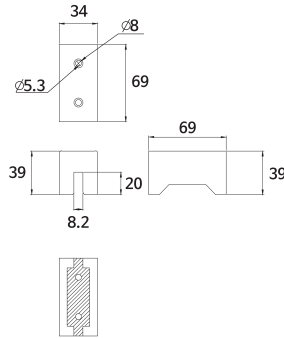

제품명	IWP01D
제품 사양	재료 : E.V.A 포장단위 : 3,000EA 색상 : 백색, 회색, 흑색
용도	85mm EVA 풍지판

IST04D

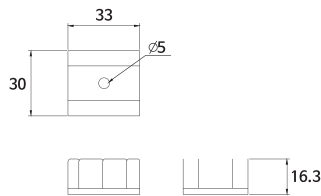

제품명	IST04D
제품 사양	재료 : PP 포장단위 : 2,000EA 색상 : 백색, 회색, 흑색
용도	110mm 스톱바

IST05D

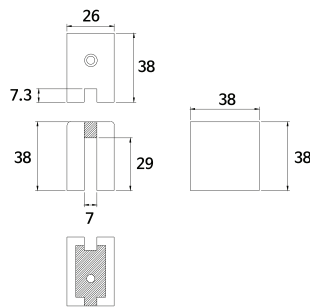

제품명	IST05D
제품 사양	재료 : E.V.A 포장단위 : 2,000EA 색상 : 백색, 회색, 흑색
용도	84mm 스톱바

IST06D

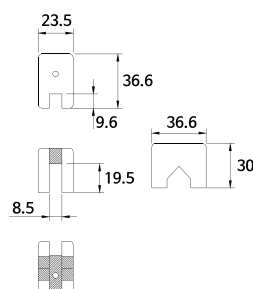

제품명	IST06D
제품 사양	재료 : CALPET 포장단위 : 500EA 색상 : 백색, 회색
용도	85mm SF 스톱바



IST07D

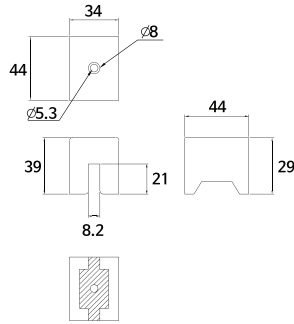

제품명	IST07D
제품 사양	재료 : CALPET 포장단위 : 400EA 색상 : 백색, 회색, 흑색
용도	110mm SF 스톱바

IST08D

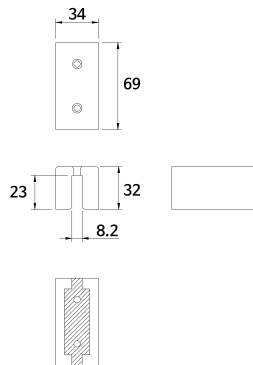

제품명	IST08D
제품 사양	재료 : CALPET 포장단위 : 500EA 색상 : 백색, 회색, 흑색
용도	125mm SF 스톱바

IPS09D

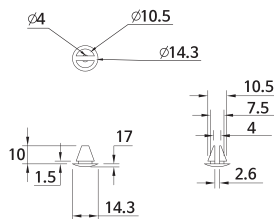

제품명	IPS09D
제품 사양	재료 : LDPE 포장단위 : 50,000EA 색상 : 백색, 회색, 흑색
용도	80mm 피스마개(소)

IPS10D

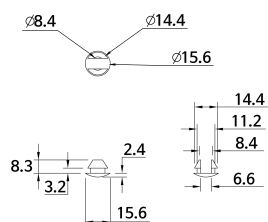

제품명	IPS10D
제품 사양	재료 : LDPE 포장단위 : 30,000EA 색상 : 백색, 회색, 흑색
용도	피스마개(대)

IIC15D

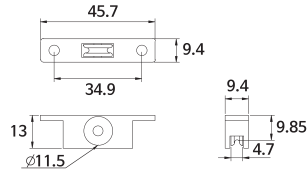

제품명	IIC15D
제품 사양	재료 : PP 포장단위 : 5,000EA
용도	방충망 롤러(소)

IIC16D

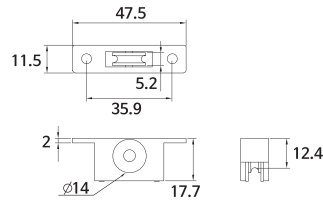

제품명	IIC16D
제품 사양	재료 : PP 포장단위 : 5,000EA
용도	방충망 롤러(대)

IMH17D

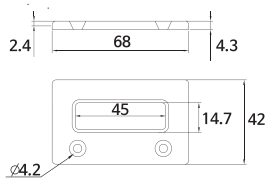

제품명	IMH17D
제품 사양	재료 : PP 포장단위 : 3,000EA 색상 : 백색, 회색, 흑색
용도	방충망 핸들(소)

IMH18D

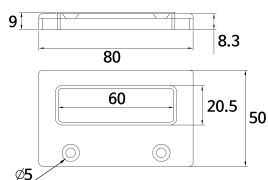
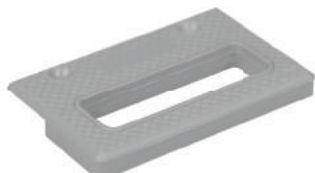

제품명	IMH18D
제품 사양	재료 : PP 포장단위 : 3,000EA 색상 : 백색, 회색, 흑색
용도	방충망 핸들(대)



IGU21D

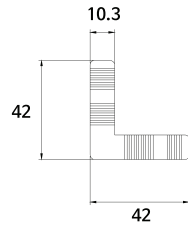

제품명	IGU21D
제품 사양	재료 : PP 포장단위 : 3,000EA
용도	9mm 철심건구

IGU23D

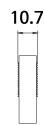
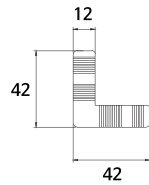

제품명	IGU23D
제품 사양	재료 : PP 포장단위 : 3,000EA
용도	11mm 철심건구

IGU26D

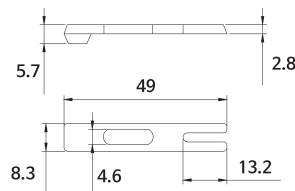

제품명	IGU26D
제품 사양	재료 : PP 포장단위 : 10,000EA 색상 : 백색, 회색, 흑색
용도	84mm 이탈방지기

I N D E X

○ 핸들 Handle(8~17p)



H01F(블랙/골드)



H02F(실버)



H03F(실버 밀판O)



H03F(실버 밀판X)



H03L(실버/화이트)



H03M(실버/화이트)



H05L(실버)



H08G(실버)



H08L(실버)



H08M(실버)



H09G(다크그레이)



H09L(실버 향균)



H09LA(실버)



H09M(실버 향균)



H09MA(실버)



H09S(실버 향균)



H09SA(실버)



H10G(실버)



H10L(실버)



H10M(실버)

○ 키퍼&스트라이크 keeper&Strike(18-21P)



K01



K02



K05



K06



K21



K18



S01



S02



S06



S14



021



S18

○ 롤러 Roller(PVC용)(22~30p)



RP01S



RP01T



RP02S



RP02T



RP03S



RP03T



RP04S



RP05T



RP06T



RP10S



RP12S



RP13S(14.5)



RP13S(15.5)



RP13S(17.5)



RP13S



RP15T



RP21S



RP22S



RP29T



RP30S



RP33S



RP34S



RP52S



RP53S



RP01S(Y)



RP01T(Y)



RP47S

○ 롤러 Roller(AL용)(31~33p)



RA01S



RA01T



RA05S



RA08S



RA10S



RA12S



RA13S

○ 크리센트 Crescent(33p)



C08M



C08S

○ 사출물 Injection(PVC용)(34~35p)



IST38D



IST39D



IST40D



IST41D



IST42D



IST43D



IST44D



IST45D



IWP51D



IWP52D



IWP53D



IST46D



IST47D



IST48D



IST49D



IST50D



IWP54D



IWP56D



IWP57D



IST51D



IST52D



IST53D



IST54D

○ 사출물 Injection(AL용)(36~39p)



IWP01D



IST04D



IST05D



IST06D



IST07D



IST08D



IPS09D



IPS10D



IIC15D



IIC16D



IMH17D



IMH18D



IGU21D



IGU23D



IGU25D



IGU26D



www.aceinnotech.co.kr

에이스이노텍(주)

본사 : 대구광역시 달성군 다사읍 세천로 1길 12

서울사무소 : 서울특별시 마포구 연남동 562-10 203호

주문전용 : TEL. 053-356-8424 / FAX. 053-356-8426 / 제품상담전용 : 053-356-8425

문의메일 : ace@aceinnotech.co.kr